



SOSEN LED Driver, Your Smart Choice

Specifications

SS-240MS Series LED Driver

Model: SS-240MS-XX

Description: 240W LED Driver

Rev.: V02

Release Date: 2026-05-15

SS-240MS Series LED Driver

SOSEN
LED DRIVER



LED DRIVER

MS Series



Features:

- Input voltage: 180-528Vac
- Efficiency up to 94%
- Dimming: 0-10V, PWM, Resistor, Timing
- Isolated Dim-to-Off
- Surge protection: IEC: CM: 10kV, DM: 6kV
ANSI: CM: 6kV, DM: 6kV
- AUX Power: 12V/0.2A
- Standby Power < 1W@480Vac; < 0.5W@230Vac
- Constant Lumen O/P
- Lifespan Early Warning
- LED module over-temperature protection
- IP66/IP67
- Communication function with PC
- Type HL, suitable for hazardous locations
- Protections: SCP/OTP/OVP/UVP
- Warranty: 5 years

RoHS **IP67** **FC**

SELV **IP66** **UL**
LISTED
E360758
Type HL

Description:

SS-240MS series product is 240W constant current LED Driver with wide O/P voltage range and adjustable O/P current by program. LED luminaries manufactures can easily design luminaries and reduce cost.

Applications:

Stadium lighting, Horticultural lighting, High Mast Lighting, Fish lighting, Street lamps, floodlights, industrial and mining lamps.

Model List:

Model	AC Input Range	Max. Pout	Vout Range	Full Power Working Voltage	Iout	Default Output Current	THD (Typ.)	PF (Typ.)	Eff. (Typ.)	Max.Tc
SS-240MS-56*	180-528Vac	240W	18-56V	36-56V	0.7-6.7A	4.9A	5%	0.96	94%	90°C

Note:

1. Default Tested: at 480Vac, full load, Ta 25°C;
2. The performance of the LED Driver can be guaranteed within the full power Vo range. The voltage lower than full power Vo range, it is need to test the performance with the LED module.

SS-240MS Series LED Driver

“*” Means Additional Function

“*”	DALI (suffix:D)	AUX 12V (suffix:H)	NTC (suffix:N)	Timing	0-10V/PWM Dim /Resistor (suffix:B)	Output- Ground	Remark
BH		✓		✓	✓		
BHN		✓	✓	✓	✓		

Input Characteristics:

Parameter	Min.	Typ.	Max.	Remark
Rated AC Input Range	200Vac		277Vac	<Ta:50°C
	277Vac		480Vac	<Ta:55°C
AC Input Range	180Vac		528Vac	
Input Frequency Range	47Hz	50/60Hz	63Hz	
Max Input Current			1.5A	200Vac, Full load
Max Input Power			300W	200Vac, Full load
Max Inrush Current(230Vac)			38A	Cold start
Max Inrush Current(347Vac)			42A	Cold start
Max Inrush Current(400Vac)			54A	Cold start
Max Inrush Current(480Vac)			59A	Cold start
Standby Power			0.5W	230Vac/50Hz 60Hz, Dim-off
			1.0W	480Vac/50Hz 60Hz, Dim-off
Power Factor	0.95			480Vac/50Hz 60Hz, Full load
	0.90			200-480Vac, 60-100% load
THD		5%	10%	480Vac/50Hz 60Hz, Full load
			20%	200-480Vac, 60-100% load

SS-240MS Series LED Driver

O/P Characteristics(SS-240MS-56*):

Parameter	Min.	Typ.	Max.	Remark
O/P Voltage Range	18V		56V	Power derated @18-36V
Rated O/P Voltage	36V		56V	$P_o=V_o \cdot I_o=241.2W$, Full load
Rated O/P Current	4.3A		6.7A	6.7A for 36V,4.3A for 56V
Adj. O/P CurrentRange (AOC)	0.7A		6.7A	Adjustable by program
No Load Voltage			60V	
Efficiency @230Vac	89.0%	91.5%		O/P 56V/4.3A
Efficiency @400Vac	91.5%	93.5%		O/P 56V/4.3A
Efficiency @480Vac	92.0%	94.0%		O/P 56V/4.3A
O/P Current Tolerance	-5%		+5%	Full load
O/P Current Ripple(PK-AV)		5%	10%	Full load
Start-up Current Overshoot			10%	Full load
Start-up Time			0.5S	200-480Vac,Full load
Line Regulation	-1%		+1%	Full load
Load Regulation	-1%		+1%	
Temperature Coefficient	-0.03%/°C		+0.03%/°C	Tc:0°C~90°C
OTP	90°C	95°C	100°C	Drop current when OTP, and it can be automatically restored after the abnormality is removed.
Short Circuit Protection				Driver will not be damaged,and it can be automatically restored after the abnormality is removed.

SS-240MS Series LED Driver

Other Characteristics:

Parameter		Min.	Typ.	Max.	Remark
AUX Power	O/P Voltage	10.8V	12V	13.2V	
	O/P Current			200mA	Operate max 15min at 400mA
0-10V Positive Dimming (Configurable)	Dim Vmax	0V		12V	DIM+ source current 110uA. Dimming prohibits reverse connection Configurable to 0-5V
	Dim Range	10%Iomax		100%Ioset	
	Rec.Dim Range	0V		10V	
10-0V Negative Dimming (Configurable)	Rec.Dim Range	0V		10V	DIM+ sink current I _{max} 40uA. Dimming prohibits reverse connection Configurable to 5-0V
PWM Dimming (Optional)	PWM High	9.8V		10.2V	DIM+ source current 110uA. Dimming prohibits reverse connection
	PWM Low	0V		0.3V	
	Frequency	1KHz		2KHz	
	PWM Duty	0%		100%	
Resistor Dimming (Optional)	Resistance	0Kohm		100Kohm	Not available with negative logic
	Dim Range	10%Iomax		100%Ioset	DIM+ source current 110uA .
0-10V Dim to Off	Dim off	0.7V	0.8V	0.9V	If the led is less than maximum rated output voltage of 75%,the luminaries may possibly have slight light when dim-to-off. Thus the whole lighting system needs to be tested
	Dim on	0.8V	0.9V	1.0V	
10-0V Dim to Off	Dim off	9.0V	9.2V	9.4V	
	Dim on	8.8V	9.0V	9.2V	
Timing Curve(Optional)		By programming			
Constant Lumen(Optional)		By programming			
Life Warning(Optional)		By programming			
NTC function(Optional)					10KΩ B3950K 10KΩ B3435K

SS-240MS Series LED Driver

Other Characteristics:

Life Time($T_c \leq 80^\circ\text{C}$)	50,000 hours	Rated full load
MTBF	200,000 hours	480Vac, Full load, $T_a = 25^\circ\text{C}$ (MIL-HDBK-217F)
IP Grade	IP66/IP67	
T_c	90°C	
Warranty	5 years	$T_c: 80^\circ\text{C}$
Net Weight	1200g	
Dimension	218mm*76.5mm*38.5mm	L x W x H

NOTE: 1. All the parameters above are tested $T_a 25^\circ\text{C}$ and LED load, unless specified.

2. When using resistor dimming (parallel connection of dimming wires), if the number of parallels is: N, the dimming resistor should be realized 0-100% dimming range, resistance value: $91\text{K}\Omega/\text{N}$.

SS-240MS Series LED Driver

Environmental Requirements

Parameter	Min.	Typ.	Max.	Remark
Operating Temperature(Tcase)	-40°C	25°C	+90°C	
Storage Temperature	-40°C	25°C	+90°C	
Operation Humidity	10%RH		90%RH	
Storage Humidity	5%RH		95%RH	
Altitude	-65m		4000m	

Safety and EMI/EMS Standards

Certification	Standard	Status	Remark
UL/cUL	UL8750	✓	
ENEC	EN 61347-1:2015/A1:2021 EN 61347-2-13:2014/A1:2017 EN/IEC62384:2020		
UKCA	EN 61347-1:2015/A1:2021 EN 61347-2-13:2014/A1:2017 EN 62493:2015		
RCM	AS/NZS61347.2.13		
CCC	GB19510.1-2009;GB19510.14-2009		
CE	EN 61347-1:2015/A1:2021 EN 61347-2-13:2014/A1:2017 EN 62493:2015		

EMI/EMS	Criterion	Remark
Conduction Emission	EN55015:2013+A1:2015 FCC Part 15 Subpart B; ANSI C63.4:2014	Class B
Radiation Emission	EN55015:2013+A1:2015 FCC Part 15 Subpart B; ANSI C63.4:2014	Class B
Harmonic Current Emissions	IEC/EN 61000-3-2	Class C
Surge	IEC/EN 61000-4-5	DM: 6kV,CM: 10kV,Criterion B
	ANSI/C82.77-5-2017	DM: 6kV,CM: 6kV,Criterion B
Ring Wave	IEC/EN 61000-4-12;ANSI/C82.77-5-2017	DM: 6kV,CM: 6kV,Criterion B

SS-240MS Series LED Driver

Safety Test Items:

Safety Test Items	Technical Indicators			Remark
Insulation Requirements	UL Insulation Requirements	ENEC Insulation Requirements	CCC Insulation Requirements	
Input-Case	2U+1000Vac	2U+1000Vac	2U+1000Vac	Basic insulation
Input-Dim	2U+1000Vac	4U+2000Vac	4U+2000Vac	Reinforced insulation
Dim-Case	500Vac	500Vac	500Vac	Basic insulation
Insulation Resistance	$\geq 10M\Omega$			Input-O/P, Test voltage: 500Vdc
Ground Resistance	$\leq 0.1\Omega$			25A/1min
Leakage Current	$\leq 0.75mA$			480Vac

NOTE:

1. SOSEN warrants the LED Driver itself complies with EMC standard. However, LED Driver's EMC should be re-checked when integrated into lighting systems due to unexpected interference as component.
2. Please short (ACL and ACN), (V+ and V-), (Dim+ and Dim - and Vaux+) when Hi-pot test.
3. The CCC withstand voltage test needs to disconnect the built-in lightning protection tube. According to the IEC 60598-1:2014 standard section 10.2, the “built-in lightning protection tube” can be marked on the nameplate to disconnect the discharge tube on testing.

Performance Curves:

Input Inrush Current

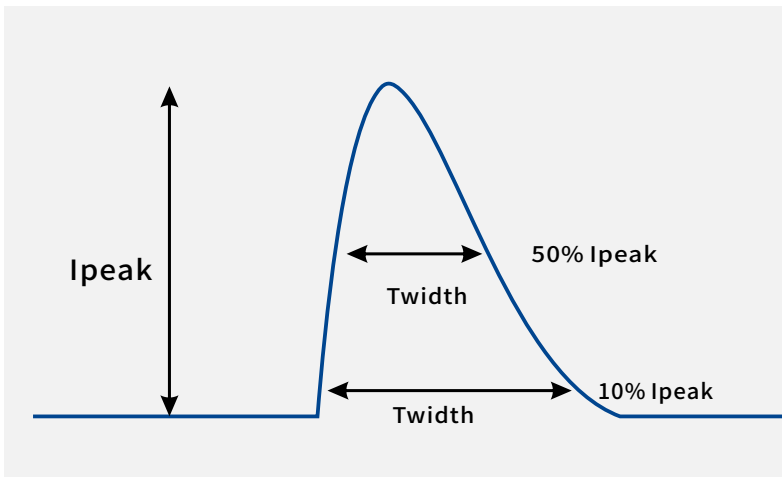

Vin	Ipeak	T(@10% of Ipeak)	T(@50% of Ipeak)
230Vac	38A	866uS	322uS
347Vac	42A	926uS	340uS
400Vac	54A	912uS	358uS
480Vac	59A	898uS	354uS

SS-240MS Series LED Driver

Performance Curves:

O/P Voltage Vs. O/P Current(Dim/AOC Window)

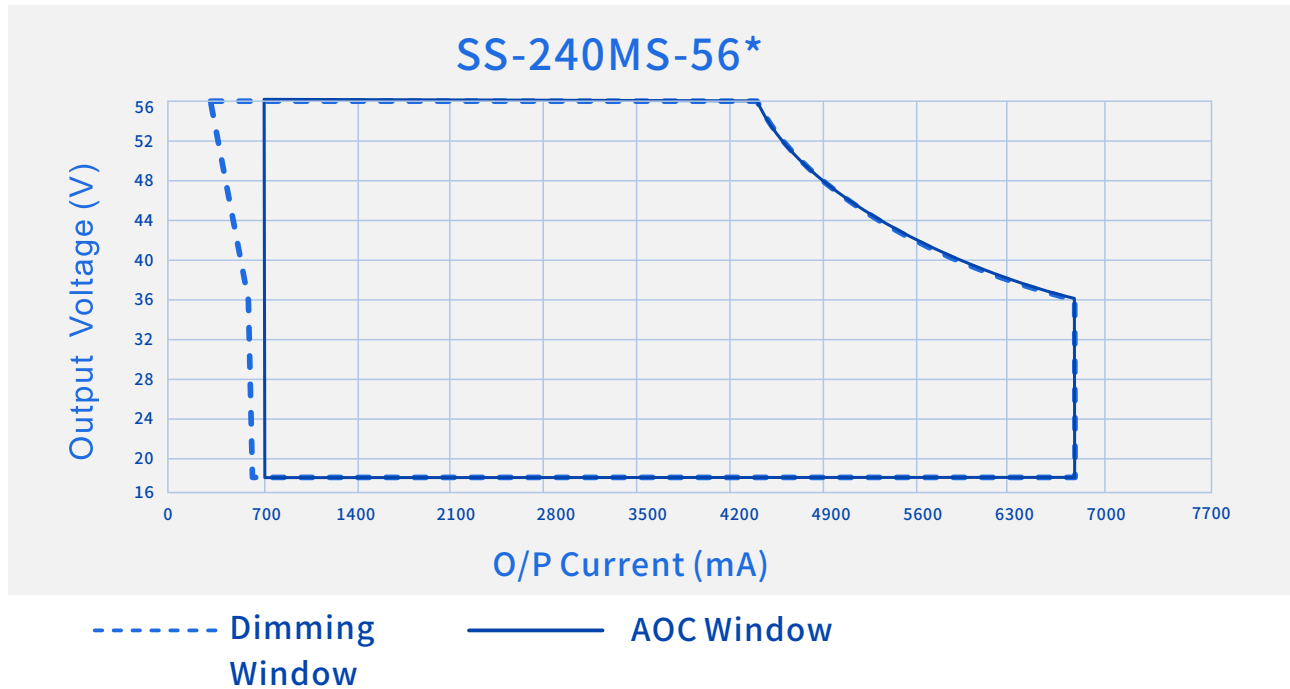

Efficiency Vs. O/P Voltage (Vin=230Vac)

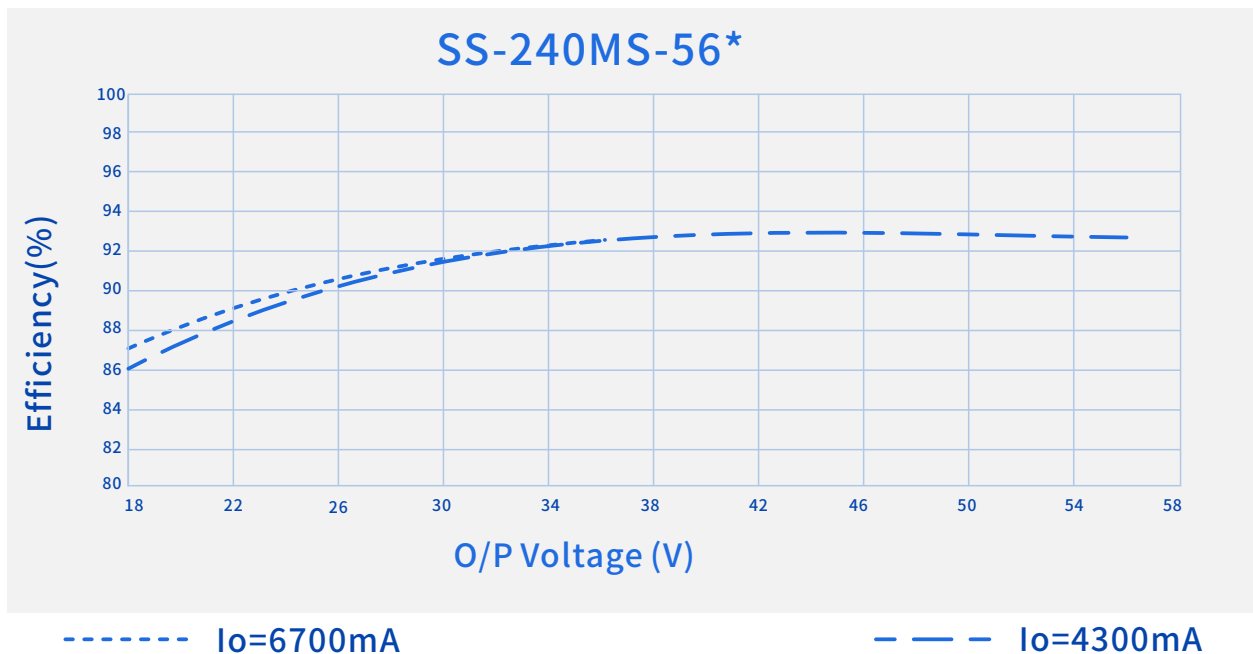

SS-240MS Series LED Driver

Performance Curves:

Efficiency Vs. O/P Voltage ($V_{in}=400V_{ac}$)

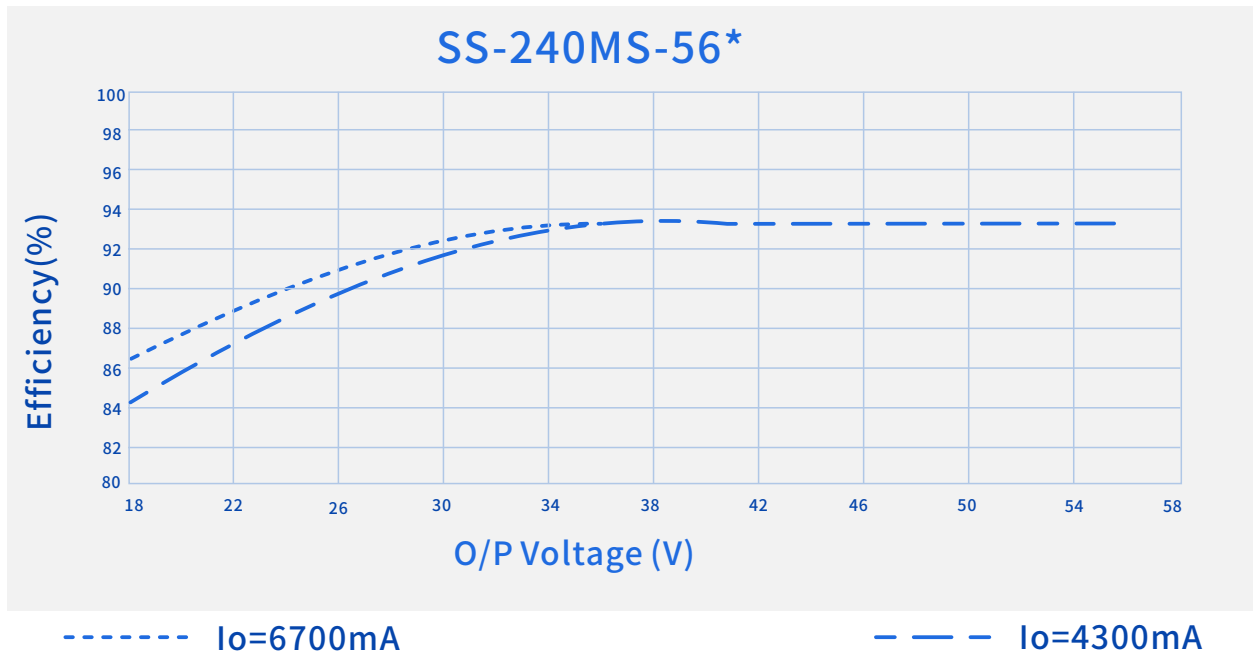

Efficiency Vs. O/P Voltage ($V_{in}=480V_{ac}$)

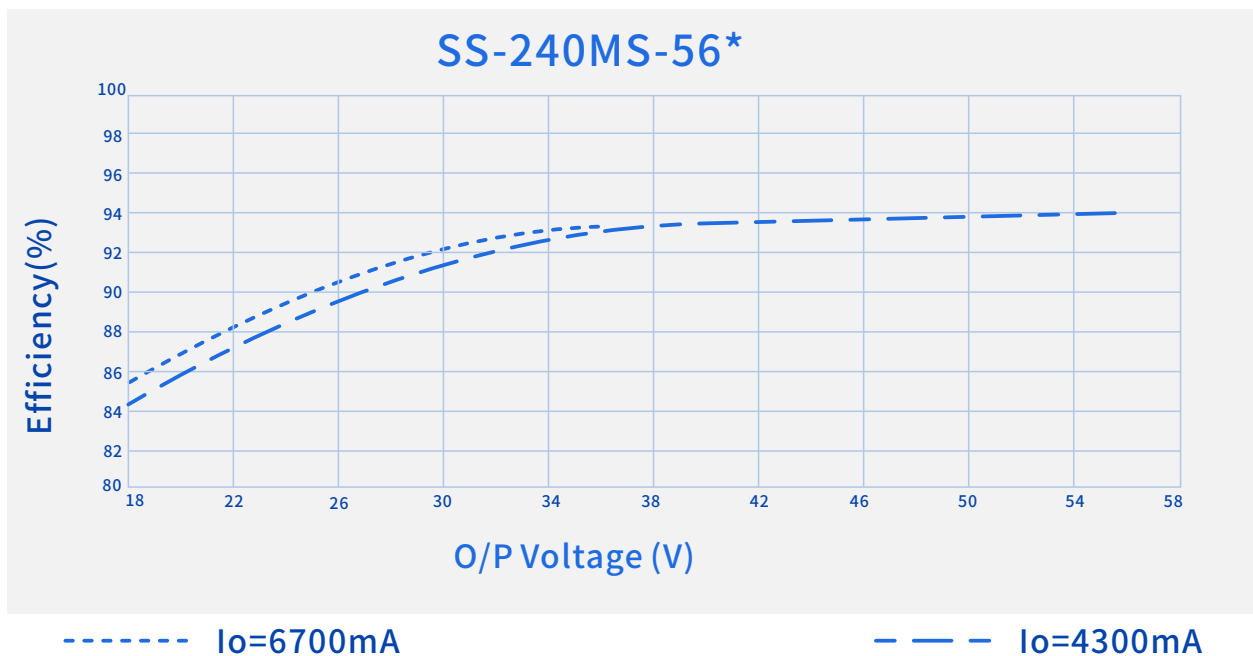

SS-240MS Series LED Driver

Performance Curves:

Power Factor Vs. O/P Power

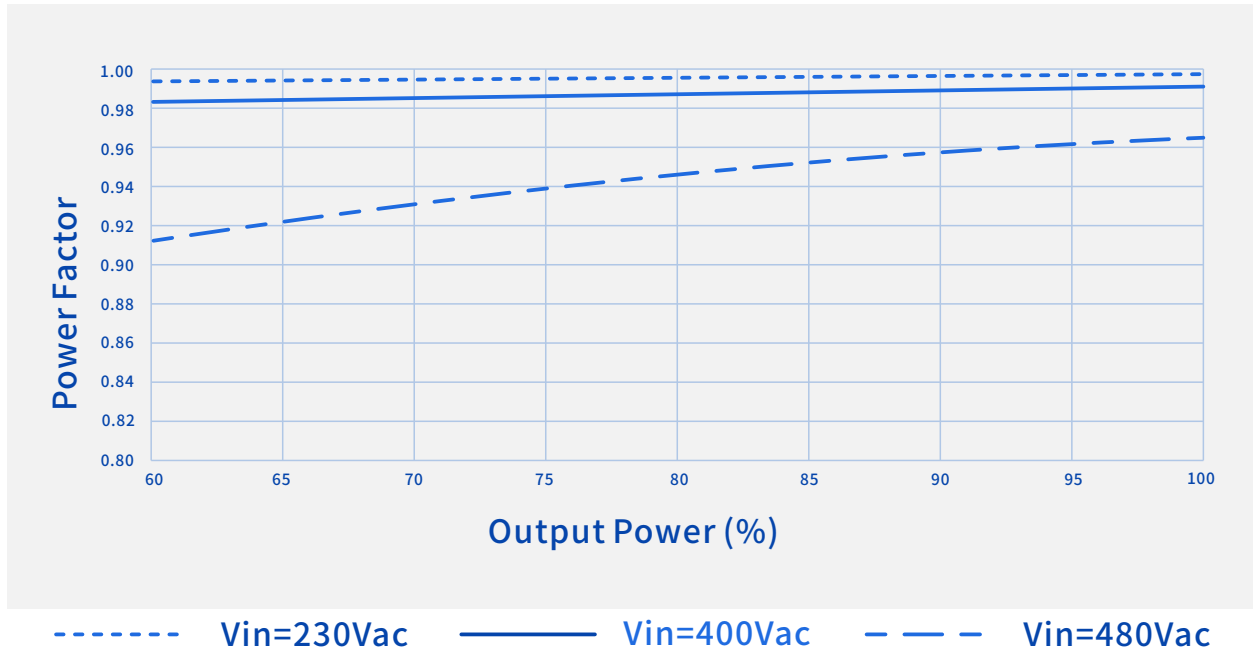

THD Vs. O/P Power

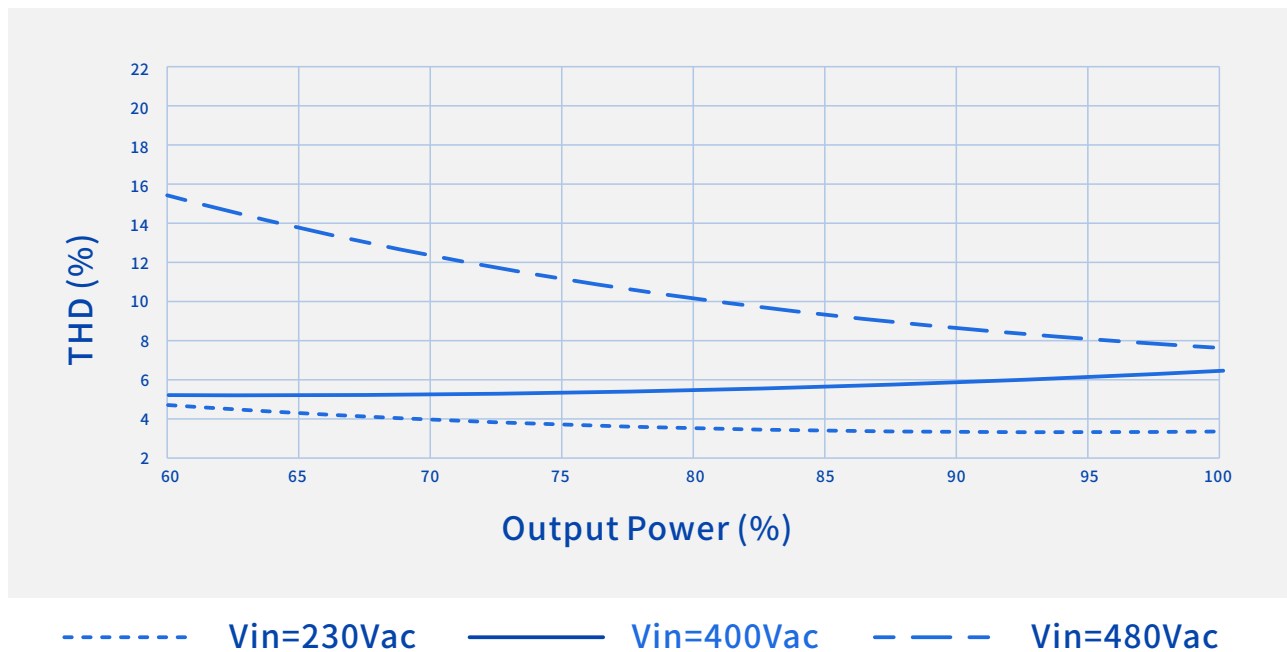

SS-240MS Series LED Driver

Performance Curves:

O/P Power Vs. Input Voltage

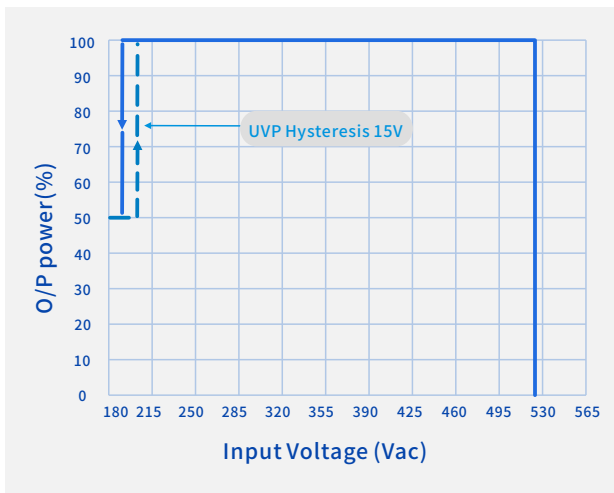

O/P Power Vs. Case Temperature

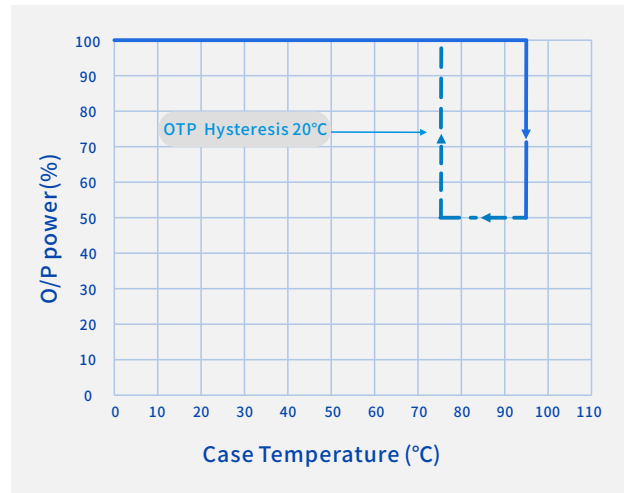

O/P Power Vs. Dimming

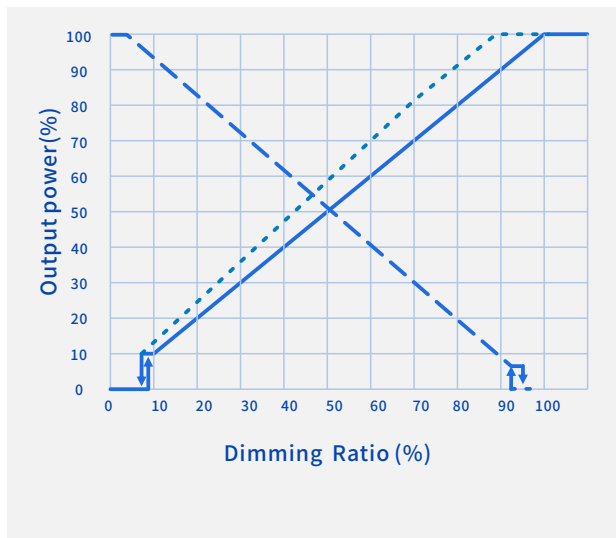

Lifetime Vs. Case Temperature

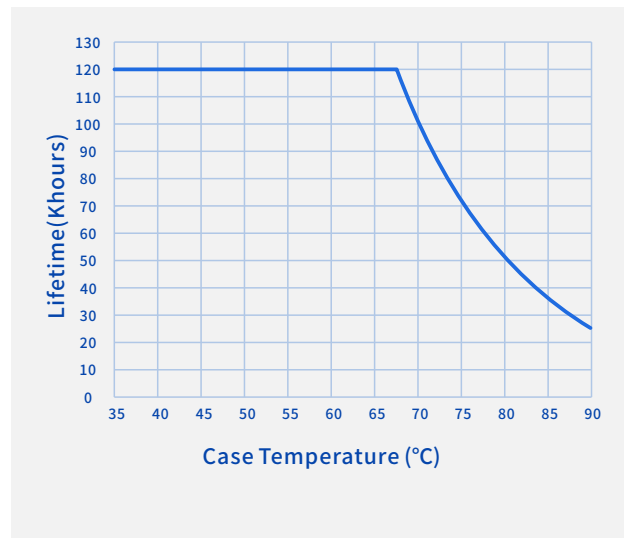

- 0-10V, 0-5V, PWM
- - - 10-0V, 5-0V
- ... Resistor Dimming (100KΩ)

SS-240MS Series LED Driver

Programming connection diagram:

Legacy Timer: Driver's O/P follows the pre-programmed timing curve after turn-on.

Auto-Adjust by Percentage: Driver's O/P will be adjusted by automatically changed dimming curve by the period percentage based on the latest 5 dimming curve.

Auto-Adjust by Mid-point: Driver's O/P will be adjusted by automatically changed dimming curve by mid-point based on the latest 5 dimming curve.

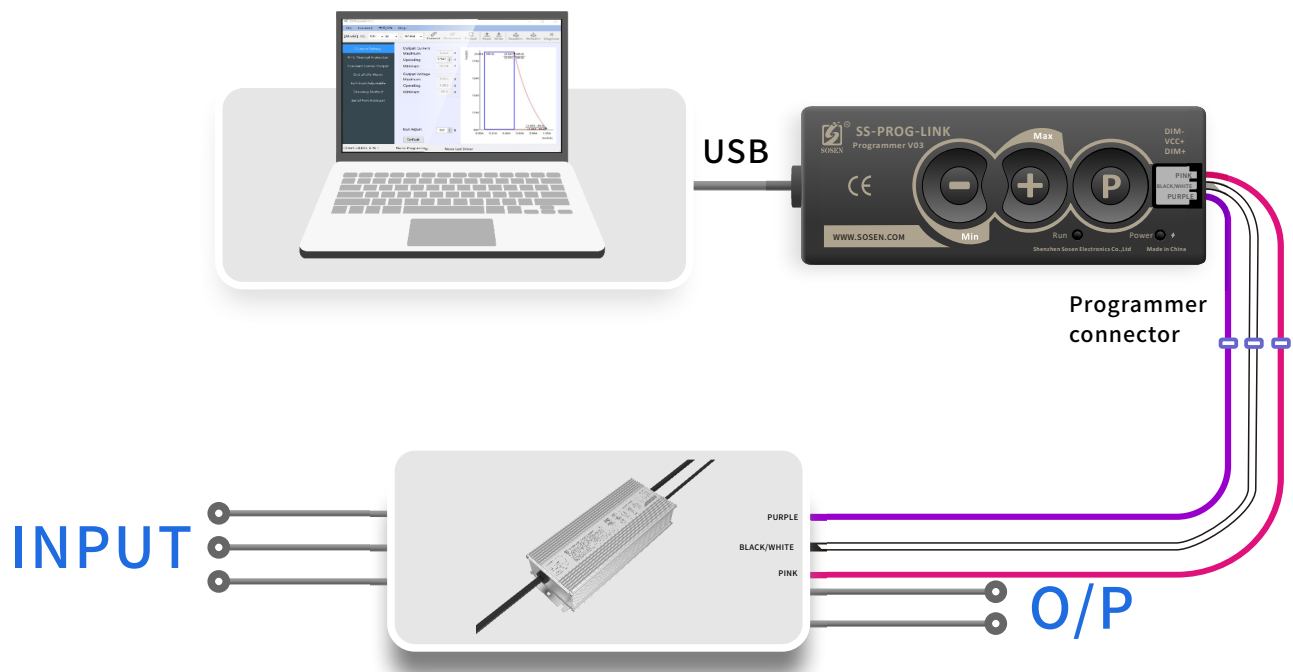

Constant Lumen Output

Constant Lumen Output are design to maintain fixture's stable output lumen by increasing driver's output current within driver's life span to counteract LED lumen degradation.

SS-240MS Series LED Driver

Mechanical Characteristics

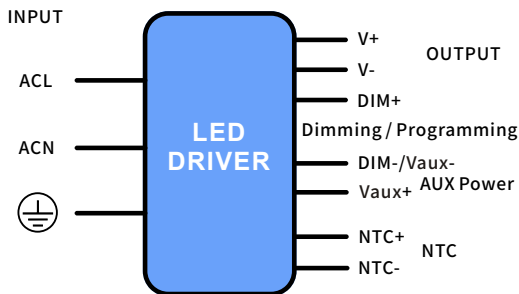

AC Input Cable(Exposed Length $450\pm 10\text{mm}$):

UL model:STW, 3*18AWG, O.D.: 9.4mm, Black: L, White: N, Green: \oplus
Global model: SOOW, 3*17AWG, O.D.: 9.8mm, Brown: L, Blue: N, Yellow/Green: \oplus

DC O/P Cable(Exposed Length $250\pm 10\text{mm}$):

UL model:SJTW, 2*18AWG, O.D.: 7.3mm, Red: V+, Black: V-
Global model: SJOW, 2*17AWG, O.D.: 7.7mm, Brown: V+, Blue: V-

BH Model:

DIM/AUX Power/Programming Cable

(Exposed Length $220\pm 10\text{mm}$):

UL/Global model: STYLE 21996, 3*22AWG, O.D.: 4.9mm, Purple: DIM+,
Pink: DIM- /Vaux-, Black/White: Vaux+

BHN Model:

DIM/AUX Power/Programming Cable

(Exposed Length $220\pm 10\text{mm}$):

UL/Global model: STYLE 21996, 3*22AWG, O.D.: 4.9mm, Purple: DIM+,
Pink: DIM- /Vaux-, Black/White: Vaux+

NTC Cable(Exposed Length $220\pm 10\text{mm}$):

UL model: SJTW, 2*18AWG, O.D.: 7.3mm, Red: NTC+, Black: NTC-
Global model: SJOW, 2*17AWG, O.D.: 7.7mm, Brown: NTC+, Blue: NTC-

SS-240MS Series LED Driver

Mechanical Characteristics

Name Description	Standard Code	mm(In.)
Overall Length	L1	218(8.58)
Mounting Hole Length	L2	210(8.27)
Case Length	L3	201(7.91)
Case Height	H	38.5(1.51)

Note:

- 1, Please follow the "LED Driver User Manual" obtained from SOSEN's official website for assembly.
- 2, AC Input Cable, DC O/P Cable, DIM/AUX Power/Programming Cable:
 Peeled length of cable: 43 ± 5 mm,
 Tinned length of wire: 10 ± 2 mm

Name Description	Standard Code	mm(In.)
Case Width	W1	76.5(3.01)
Mounting Hole Width	W2	27(1.06)
TC Point Position	X	135(5.31)
TC Point Position	Y	44(1.73)

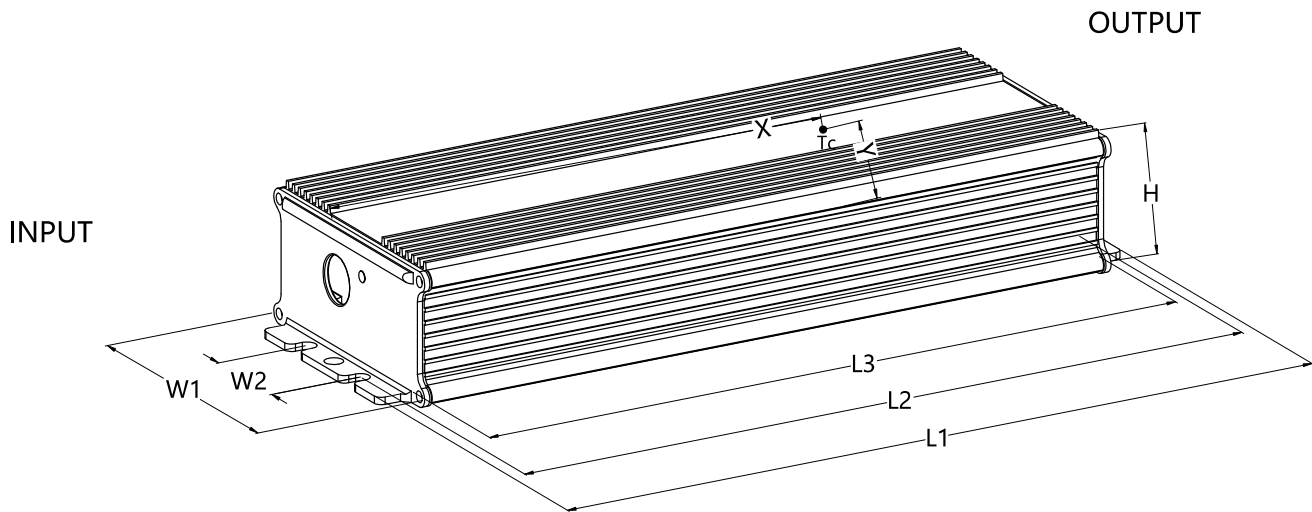

SS-240MS Series LED Driver



Assembly Tips

1. Please take isolation and waterproof measures if the dimming cable is not in use.

Package

- Outside carton dimension: L × W × H = 493mm × 385mm × 132mm;
- 7PCS/Carton;
- Net weight/Piece: 1.2kg; Gross weight/Carton: 9.3kg;
- Please refer to the product name, model number, manufacturer identification, QC PASS, manufacturing date on the package.

Transportation

Packaging is designed suitable for transportation by trucks, vessels and flights. The products should be avoided direct sunlight and rain, loaded/unloaded with caution.

Storage

The product storage meets the standard of the GB 3873—83.
Products should be rechecked if stored for over 1 year before assembly.

RoHS

Products comply with RoHS Directive (2011/65/EU) and amendment 2015/863/EU.

Revision History

Version	Description of Update	Updated Date	Remark
V00	Original Release	2024/11/15	
V01	Update Performance Curves	2025/01/08	
V02	Update Certification	2026/05/15	